

Professional partner in optical solutions

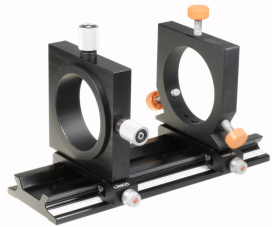

Optical Components
Liquid Lenses
Opto Mechanics
Laser & Lightsources
Laser Dyes
Spectrometers
Software
Vision & Cameras



Vadeno

OPTICAL SOLUTIONS

www.vadeno.com

Professional partner in optical solutions

Optical Components

- Singlets
- Achromats & Lens systems
- Laseroptics
- Microscope Optics
- Plane Optics
- Polarizing Optics
- Mirrors
- Gratings
- Thin Film Coatings
- Faraday Isolators
- Laser Modulators
- Pockels Cells

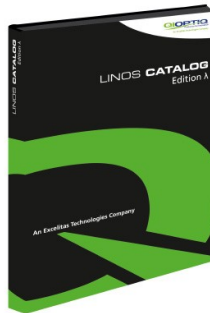

Camera lenses

- Machine Vision lenses
- Inspection lenses
- Microscope objectives
- Macro CCD lenses



Vadeno
OPTICAL SOLUTIONS

www.vadeno.com

Professional partner in optical solutions

Liquid lenses

The unique characteristics of Corning Varioptic Lenses offer:



- No moving parts
- Hundreds of millions of cycles endurance
- Speed: much faster than mechanical actuators
- Robustness and unmatched mechanical shock resistance: tested at 2000g / 0.25ms / 100 times (x2 directions)
- Close focus ability: from infinity to below 5 cm
- Low power consumption: <1 mW (~20 mW with driver)
- Silent operation



Applications:

- Barcode readers
- Biometrics
- Endoscopes
- Lasers
- Low vision devices
- Machine vision
- Medical imaging
- Ophthalmology equipment



 **Vadeno**
OPTICAL SOLUTIONS

www.vadeno.com

Professional partner in optical solutions

Opto Mechanics

QIOPTRIX
Photonics for Innovation
An Excelitas Technologies Company

- Microbench
- Nanobench
- Tube System C
- Positioners
- Rail Systems
25 - 95 mm
Carriers
- Mounts & Posts
- Breadboards
- Mounting plates
- Mirror Mounts
Lees Mirror Mounts

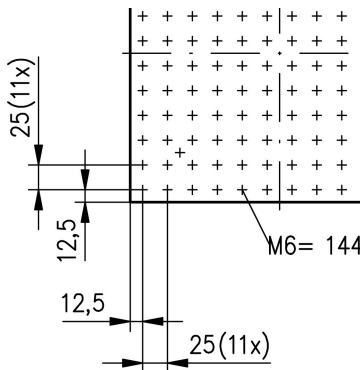
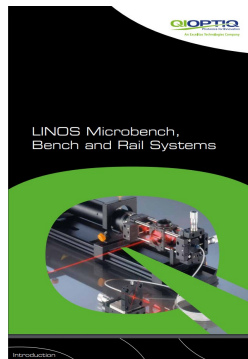

Vadeno
OPTICAL SOLUTIONS

www.vadeno.com

Professional partner in optical solutions

Lasers

- HeNe lasers
- Solid State lasers
- Diode lasers
- Line lasers
- Multi color lasers
- Single longitudinal mode lasers
- Low noise lasers
- High power diodes
- DPSS lasers



Oxxius
Simply Light

PEGASUS
Linienlaser Diodenlaser Festkörperlaser

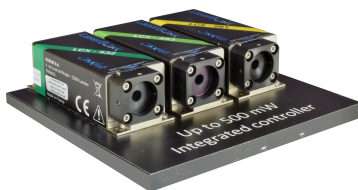

Applications:

- Biophotonics
- Measurement & spectroscopy
- Low frequency Raman spectroscopy
- Industrial application and many more...

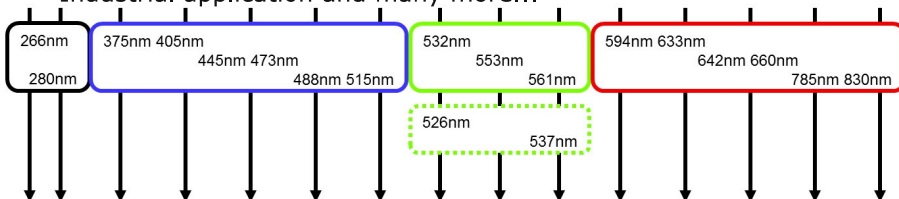

Vadeno

OPTICAL SOLUTIONS

www.vadeno.com

Professional partner in optical solutions

Near-infrared lasers in an entirely new wavelength range

Nanosystems and
Technologies
GmbH

nanoplus

The primary products of nanoplus are single mode DFB lasers in the NIR and MIR spectral range for:

- sensing
- metrology
- spectroscopy
- telecom application

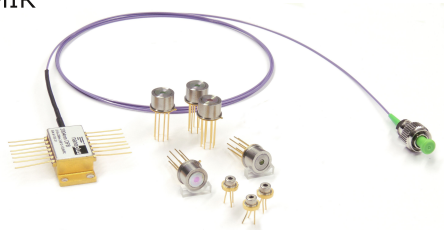

- DBF diode lasers (760-3000 nm)
- DFB ICL;s (3-6 μm)
- Quantum cascade lasers (6-10 μm)

Lightsources: Cold light and LED's

The perfect solution for applications requiring intensive, infrared-free lighting in which the light selectively guided to the object via fibre-optic components



Applications:

- Inspection / surface inspection
- Technical endoscopy
- Machine Vision
- Microscopy



 **Vadeno**
OPTICAL SOLUTIONS

www.vadeno.com

Professional partner in optical solutions

X-Cite® Fluorescence Illuminators for Microscopy & Analytical Instrumentation

Fluorescence Microscope Light Sources

X-Cite®
Fluorescence Illumination • In Control

X-Cite offers a wide range of lamp and LED light sources and fluorescence illumination systems ideal for a variety of microscopy applications. From our standard X-Cite 120Q model used for routine assays, to our most advanced high-end X-Cite XLED1 and X-Cite TURBO, X-Cite has the right fluorescence illumination system for your application. The X-Cite XYLIS features our newest broadband technology providing LED illumination powerful enough to match the output of a lamp!



How does one choose a microscope light source?



Selecting a fluorescence microscope light source depends on the application. How fast are you acquiring images? How much intensity control do you need for your light source? How fast do you need to shutter the light? What fluorophores are you exciting? Find out which system is most suitable, or contact us for your application.

Vadeno
OPTICAL SOLUTIONS 12.5 YEARS CELEBRATION

www.vadeno.com

Professional partner in optical solutions

Highest quality dyes and specialty chemicals



Exciton is supplying the highest quality laser dyes, absorber dyes, and specialty chemicals over 40 years. Exciton continuously strive to bring new dyes to market across spectral regions from the infrared to the ultraviolet. Exciton introduces the latest science in the form of new dyes with superior performance.

Laser & Fluorescent Dyes

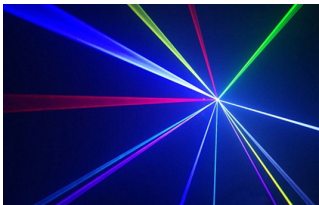

Dyes and dye lasers still provide the unique combinations of power, pulse length, wavelength and reliability that are required for many applications. Our products are used in research laboratories and medical offices around the world.

Absorber Dyes



Selective light filtration (absorption) is key to the performance of many optical products from ophthalmic lenses for laser protection and enhanced contrast, to filters for digital sensors (cameras). Our non-fluorescent narrow band visible and infrared dyes are incorporated into products that are sold globally.



www.vadeno.com

Professional partner in optical solutions



GoSPECTRO

The power of spectroscopy at your fingertips

The Most Mobile Spectrometer

- Compatible with most smartphones and tablets
- Dedicated mobile applications - available on Android and iOS
- Live spectra at video rate

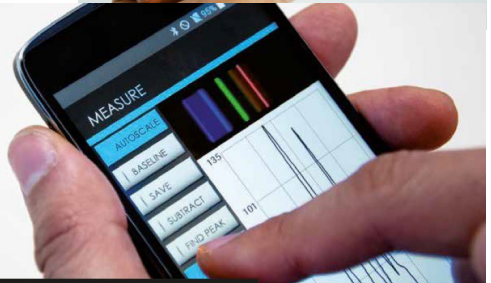

 **Vadeno**

OPTICAL SOLUTIONS 12.5 YEARS CELEBRATION

www.vadeno.com

Professional partner in optical solutions



1. MEASURE

Point to a light source or object with sufficient lighting.
Watch the spectrum on the display.
Press SAVE to record a spectrum.

2. EXPORT

Send spectra by e-mail, to the cloud or to your computer via USB.



3. ANALYSE

Fine peak positions, perform baseline correction and spectral subtraction, compare spectra with databases.

KEY APPLICATIONS GoSPECTRO



GEMOLOGY

Hands-free analysis
Nanometric scale measurements
Gem analysis, storage & data export
No eye fatigue



AUTHENTICATION

Portable reader for anti-counterfeit labels (fluorescent ink)
Direct authentication of products in real time
Easy to use



EDUCATION & RESEARCH

Playful way to learn spectroscopy with a smartphone
Tutorials available
Affordable material



LIGHTING

Light spectrum characterization
Wavelength calibrated measurement
Optical filters characterisation



OPTICAL SOLUTIONS 12.5 YEARS CELEBRATION

www.vadeno.com

Professional partner in optical solutions

Software

WinLens: Optical Design Software (Free)



[Qioptiq Lens Calculator](#) for Android
Find it in the Google Playstore

[MachVis](#): Machine Vision Lens Selector

Using 4 simple parameters — object size, working distance, sensor size and camera mount — MachVis calculates the necessary optical parameters and then pre-selects all suitable lenses that meet the specifications.

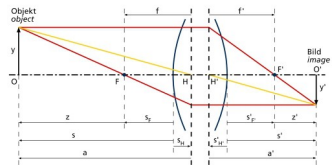

- create on-axis and folded systems
- model lenses, mirrors, prisms, gratings and HOEs
- serious optical engineering features
- ideal for learning and



teaching
technical
optics



Vadeno

OPTICAL SOLUTIONS 12.5 YEARS CELEBRATION

www.vadeno.com

Professional partner in optical solutions



Software

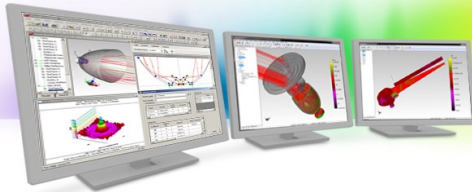

TRACEPRO®: Illumination design, analyses and Optimization Software

A seamlessly integrated suite of optical and opto-mechanical design tools includes: TracePro®, TracePro Bridge and a menu of add-ins enabling streamlined workflow and interoperability among other commercially available optical and mechanical design software tools.

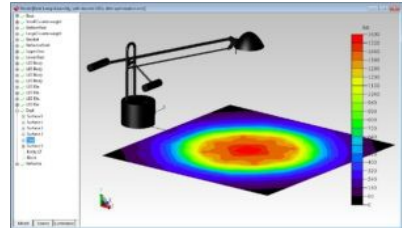

TRACEPRO® offers engineers and scientists the confidence that the performance of the finished products will concur with the simulated design without costly prototype iterations.

*Interested? Try our 14-day free trial of
TracePro and TracePro Bridge.*



www.vadeno.com

Professional partner in optical solutions

Vision - Cameras

Applications:

- Aviation
- Automotive
- Microscopy
- Defense
- Measurement
Light Measurement
Machine Vision
- Medical
- Power Distribution
- Unmanned Vehicles

Interfaces:

- Analog Video
- CameraLink
- Fast Ethernet
- Gigabit Ethernet
- HDMI 1.3
- HD-SDI
- USB 2.0
- ... this is just an extract from
our portfolio

kappa 



Customizable high performance FPGA cameras

Cameras with the stereoscopic eye of the Cameleon, the extensibility and flexibility of the Camelopard and the speed of the Velociraptor!

NEW: T-REX is the ultimate FPGA camera with a very large Xilinx Zynq FPGA and high speed imaging sensor.



OPTOMOTIVE

 **Vadeno**

OPTICAL SOLUTIONS 12.5 YEARS CELEBRATION

www.vadeno.com

Professional partner in optical solutions

Our expertise in the world of Photonics makes us the perfect partner and supplier for you.

You can count on Vaden Optical Solutions to plan, design, develop and produce the most demanding optical systems exactly to your specifications.



You can turn to Vaden Optical Solutions for...

Optical Solutions for research and investigation

Optical devices for production equipment

Lasers, Illumination and lighting

Imaging

Security and construction

Optical recognition

Fabric and tissue production

Space applications

Spectroscopy and Raman

Assembly equipment

Semiconductors

Food inspection

Free space optical communication

Biotech Lab instruments

And much more...

OPTICAL SOLUTIONS

www.vaden.com

Professional partner in optical solutions

Our suppliers train and advise us for the best way to use the products.
With more than 25 in business we can say: "We have experience".

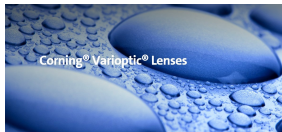

Nanosystems and
Technologies
GmbH

nanoplus



VADENO Optical Solutions

Oude Beekbergerweg 1

7331 HL Apeldoorn

The Netherlands

Phone +31 610 414 067

email info@vadeno.nl



www.vadeno.com

